

FROM ALL SIDES TO BRING IT DOWN - DIANE PRIMA IT WILL TAKE ALL

FROM ALL SIDES TO

NO ONE WAY WORKS

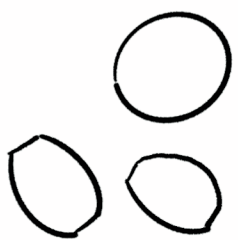
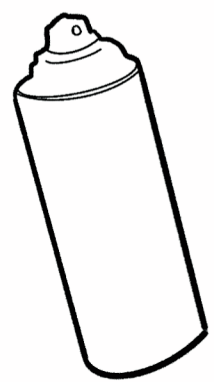
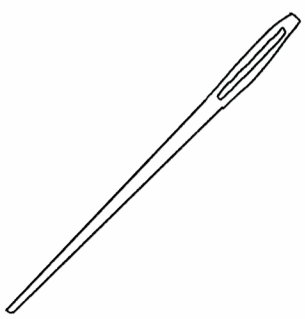
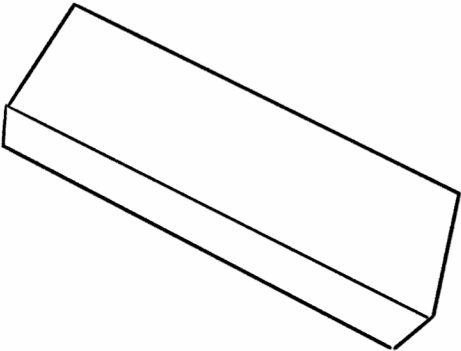
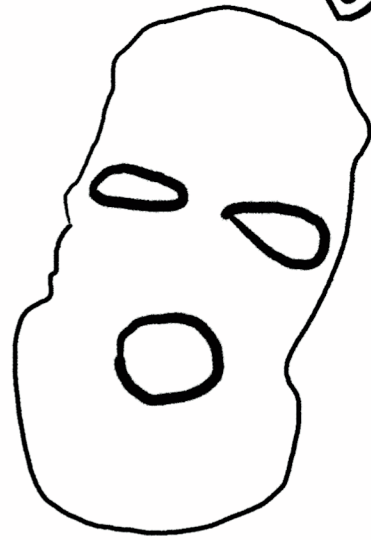
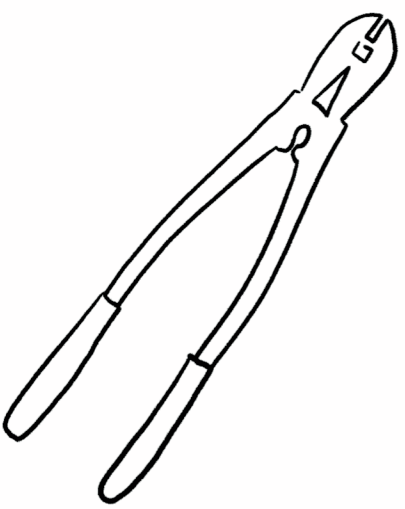
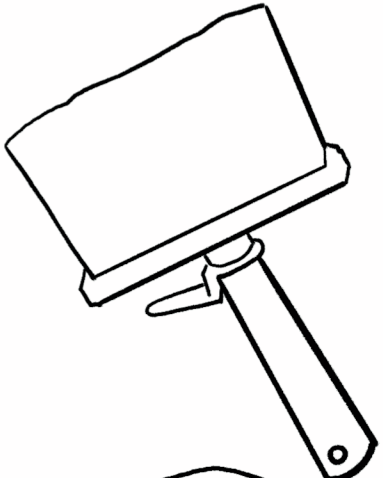
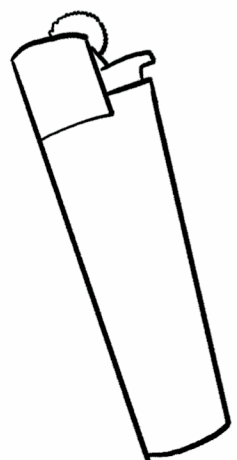
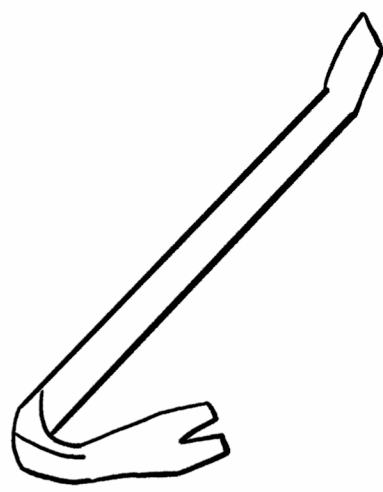
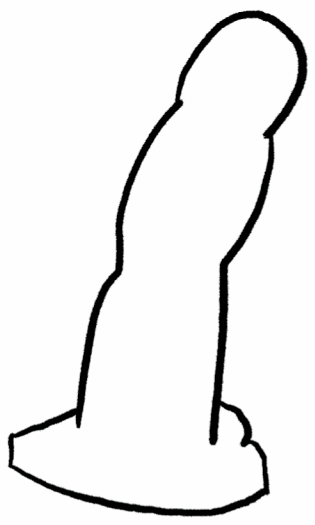
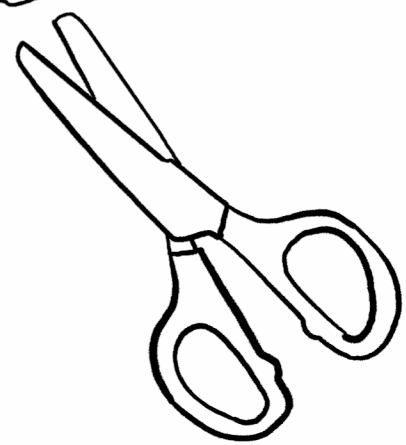
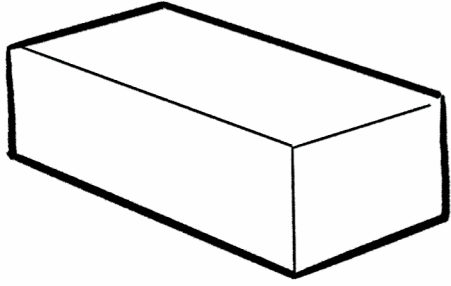
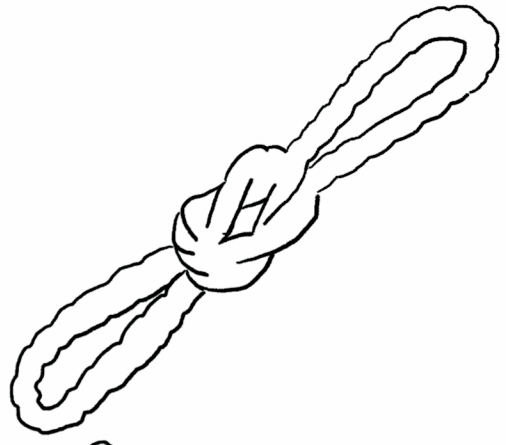
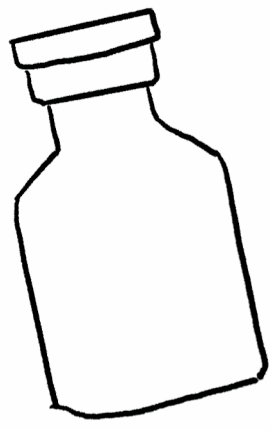
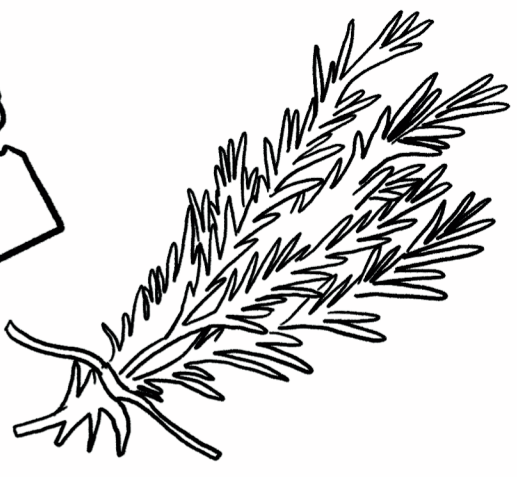
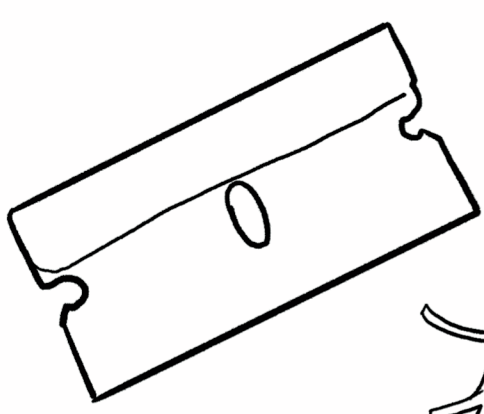

IT WILL TAKE ALL